

Emotron EMX™ - R DRIVE SYSTEM



Instruction manual
English

Valid for the following models:

EMX-R-15S

EMX-R-15E

EMX-R-25S

EMX-R-25E

EMX-R-35S

EMX-R-35E

Software version 2.x

Emotron EMXTM-R DRIVE SYSTEM INSTRUCTION MANUAL - English

Document number: 01-3333-01

Edition: r3

Date of release: 2010-08-01

© Copyright Emotron AB 2005 - 2010

Emotron retain the right to change specifications and illustrations in the text, without prior notification. The contents of this document may not be copied without the explicit permission of Emotron AB.

The product is protected as follows:

Patents: US 6 628 100; SE 9902821-9

SE 0100814-3; SE 0100814-3; EP 1 366 346; US 7 083 544

Registered design: US 462 937; DE 400 05 393.4; SE 66 630

Safety instructions

During installation

- Read the instruction manual completely before installation and commissioning.
- The installation must be carried out by qualified personnel.
- General conditions and regulations for the installation and operation of electrical machinery must be observed.
- Measures to protect against personal injury and damage to the machine must be taken following local rules and regulations.
- The drive system EMX-R is intended for permanent installation.
- Cables may not be connected or disconnected while the supply voltage is on.
- Check that the equipment is correctly connected before it is taken into use, see the instructions in the chapter on Mounting/Connection.
- Faults that arise due to faulty installation or operation are not covered by the guarantee.

During operation

- Measurements in the control unit, during operation, must only be carried out on the terminals and only by authorized personnel. NOTE! Great care must be taken.
- The units may not be opened or disassembled during operation.

During disassembly and scrapping

- The product is designed to comply with the RoHS directive, and shall be handled and recycled in accordance with local legislations.

Contents

1.	Description.....	3
1.1	Introduction.....	3
1.2	Product range	4
1.3	Operating indicators / built-in functions	5
1.3.1	Automatic purging mode / holding torque.....	6
1.3.2	Rotation monitor (DIP switch 4).....	7
1.3.3	Protection of the control unit	8
2.	Mounting/connection.....	11
2.1	Mounting	11
2.1.1	External sensor for rotation monitor (option)	12
2.2	Connection	12
2.2.1	When switching off	13
2.2.2	Recommendations with respect to EMC.....	13
2.2.3	Priority switch / defrosting / manual control.....	14
2.2.4	Manual control using a 10 kOhm potentiometer	14
2.2.5	Test switch	14
2.2.6	Choice of maximum speed	16
2.2.7	Setting DIP switches.....	17
2.2.8	Speed controller	18
2.2.9	Parallel connection	18
2.2.10	Heat recovery on cooling – summer/winter switch.....	19
2.2.11	Analogue output signal (only available on Model E)	19
2.2.12	Potentiometer with low resistance, 100 Ohm to 5 kOhm (only available on Model E).....	19
3.	Maintenance/troubleshooting.....	21
3.1	Maintenance	21
3.2	Motor diagnosis	21
3.3	Troubleshooting.....	22
4.	Technical data	25

4.1	The drive system's operation using different control signals.....	26
4.2	Choice for sizes of drive system and belt pulley	29
4.3	Accessories and documentation	30
5.	Appendix	31

1. Description

1.1 Introduction

Emotron EMX-R is a series of speed controlled drive systems specially designed for driving rotary heat exchangers. The drive system consist of a motor and its associated control unit.

EMX-R completely replaces drive systems EMS-VVX 1, 2-4N, 2-4N/ET and 2-4EM as well as the drive systems EMS-VVX 15, 25 and 35. All mentioned drive systems have completely been replaced by EMX-R.

The drive system Emotron EMX-R is based, like its predecessor, on the SR-motors (SR=Switched Reluctance). These motors make it possible to drive heat exchanger rotors up to 3.5 metres in diameter without gears.

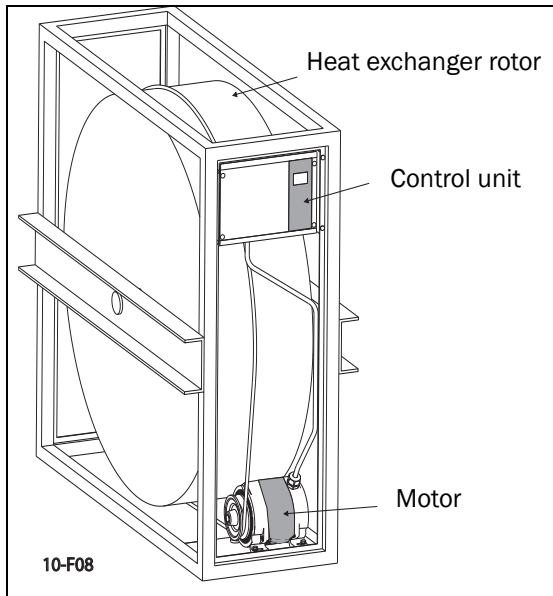

Fig. 1 Emotron Motor and Control unit for rotary heat exchangers.

1.2 Product range

EMX-R is available in three sizes for heat exchanger rotors up to around 3.5 m. They come in sizes 15, 25 and 35 (for other rotor sizes, please contact the local distributor or Emotron AB). The control unit sizes are dedicated to the motor sizes. Control unit EMX-R-15S(or E) could only work with motor EMX-R-15M and so on.

The control unit is available in two versions, S and E, where Model E has an extra circuit board for increased functionality.

Model	Operating Indicator	Max heat exchanger rotor diameter (mm)
EMX-R- 15S	Two LEDs indicating red or green	1500
EMX-R- 15E	LED display	
EMX-R- 25S	Two LEDs indicating red or green	2500
EMX-R- 25E	LED display	
EMX-R- 35S	Two LEDs indicating red or green	3500
EMX-R- 35E	LED display	

Built-in functions included in the Model S are:

- Automatic purging operation
- Rotation monitor - integrated electronics or with external rotation sensor
- Alarm relay
- Test switch
- Priority switch/defrosting
- Heat recovery on cooling with external differential thermostat

In addition to the functions included in Model S, the Model E includes:

- Display of the rotor speed in rpm when the external rotation sensor is connected.
- Analogue output signal proportional to the speed of the motor.
- Heat recovery on cooling with external temperature sensors.
- Input for potentiometer with low resistance, 100 Ohm to 5 kOhm.
- Prepared for serial communication.

1.3 Operating indicators / built-in functions

Two LEDs, one red and one green, are used on the Model S for indication, while the Model E has an LED display as follows:

Table 1 Operating indication – Model S

Green	Slow flashing – Purging mode/Low control signal
	Rapid flashing – Operation, the motor rotates continuously
	Lit for two seconds – Magnet passing rotation sensor
	Lit - RotoSens measures the load on the motor during acceleration
Red	Lit or flashing LED indicates alarm, see also the chapter on troubleshooting

Table 2 Operating indication – Model E

01	Purging mode. Low control signal
25	The speed of the rotor in rpm. At start a speed is displayed according to the gear ratio rotor/motor = 1:25. After 2 pulses from the rotation monitor, the correct speed of the rotor is displayed. Range 0.2–99 rpm.
0n	RotoSens is selected using the DIP-switch (4) and with no rotation sensor connected
.	Lit for two seconds when the magnet passes the rotation sensor
ro	RotoSens measures the load on the motor during acceleration
5	Summer operation/heat recovery on cooling
oF	No rotation monitor - DIP 4 in the OFF position and jumper between terminal 31-32
Fb	An alarm is indicated by the letter F followed by a number. See also the chapter on troubleshooting.

1.3.1 Automatic purging mode / holding torque

When the control signal is low, <1.5 V at 0–10 V, the drive system switches to purging mode. In purging mode the motor shaft turns two revolutions every 10 minutes, which is equivalent to around 30 degrees of rotation by the heat exchanger rotor. This slow rotation does not provide any significant heat transfer, but simply serves to keep the heat exchanger rotor clean.

Most of the time the heat exchanger rotor seals keep the rotor stationary, but if the rotor seals are not touching the rotor and the air flow is not perpendicular to the rotor, the air flow may cause the rotor to rotate. To prevent unintentional heat recovery in this situation the motor is automatically used to provide a holding torque to keep the rotor stationary.

The first time the drive system goes into purging mode after the power is switched on this holding torque is not activated, since many heat exchanger rotors do not require an active holding torque to keep them stationary. A rotor that does require a holding torque will then begin to turn slowly. The drive system immediately brakes this motion, reducing the speed to zero, and then applies a constant holding torque to keep the rotor stationary. The drive system has now learned which rotors require a holding torque, and which do not. The holding torque is at least 50% higher than the torque required for operation just before stand still.

If a holding torque has been applied and you grasp the drive belt and try to turn the heat exchanger rotor by hand, the torque will progressively increase.

The holding torque is generated by passing a current through one of the motor phases. The higher the torque that is required, the higher the current. This current produces a noise that gets louder as the current increases. Integrated in the control unit are three motor protection breakers, one for each motor phase. The motor protection also protects the motor when the holding torque is activated.

1.3.2 Rotation monitor (DIP switch 4)

Two different rotation monitors can be selected. The first, RotoSens™, which is an integrated electronic rotation monitor, and secondly a rotation monitor using an external rotation sensor.

RotoSens uses the motor as the sensor. By allowing the control unit to measure the load on the motor, you can determine whether the drive belt has broken. When the drive belt has broken, the motor load will be low. As the heat exchanger rotors which rotate very easily also give a low load on the motor, it is necessary to also measure the load during acceleration - you then get a measurement of the rotor's torque of inertia. After 2 minutes of operation at a low load, a load measurement is made during acceleration. If the drive belt is broken an alarm is given, if it is undamaged the load measurement during acceleration is repeated again after 24 hours. In cleaning mode, measurement during acceleration is made once every 24 hours.

The rotation monitor with external rotation sensor requires a magnet fitted on the periphery of the rotor. The magnet activates the external rotation sensor once every revolution. Should, for example, a belt break and the rotor stops, the pulses cease and an alarm is given. The time until the alarm is given is speed dependent and is 24 seconds at max. speed, 20 minutes at min. speed and about 8 hours in purge mode.

NOTE: In order to use RotoSens the load on the motor should not be too low. The minimum diameter for the heat exchanger rotor and belt pulley for each size of the drive system must be:

EMX-R-15: Belt pulley \geq 63 mm, heat exchanger rotor diameter \geq 630 mm
EMX-R-25: Belt pulley \geq 63 mm, heat exchanger rotor diameter \geq 1200 mm
EMX-R-35: Belt pulley \geq 100 mm, heat exchanger rotor diameter \geq 2000 mm

If the belt pulley or heat exchanger rotor are smaller, RotoSens can not be used, however, the rotation monitor with sensor can always be used.

The rotation monitors give alarms through operating indications (display or LED) and via the alarm relay (external signal). The motor does not stop with this alarm.

Following rotation monitor functions are available:

- DIP switch 4(see chapter 2.2.7 page 17)in position “OFF” (downwards),

means the built-in electronic rotation monitor RotoSens is connected.

- DIP switch 4 in position “ON”(upwards), means rotation monitor uses an external rotation sensor.
- No rotation monitoring, DIP-switch 4 also must be set in position “OFF”, and a jumper must be fitted between terminals 31 and 32 (“oF” is now indicated in the display on Model E).

1.3.3 Protection of the control unit

The control unit is protected by monitoring for both over-voltage and under-voltage. If the supply voltage goes over or under the allowed limits, an alarm is triggered and the motor stops. The motor starts again automatically when the supply voltage returns to its normal value. The alarm is automatically reset.

The control unit has built-in motor protection that protects against overloading, and external motor protection is not required. Power supply to the motor is cut in the event of overload. In order to restart the drive system, the supply voltage to the control unit must be temporarily disconnected for at least 5 seconds.

Built-in short circuit protection protects against short circuits between the phases of the motor and between the phases and earth.

Table 3 Protection and alarm functions

Protective function	External alarm with alarm relay	Restart	Alarm reset
Supply fault, over-voltage	Yes, immediately	Automatic	Automatic
Supply fault, under-voltage			
Pre-alarm, rotation monitor	No	Motor not stopped	1)
Rotation monitor	Yes		
Pre-alarm, motor protection/over-load	No	The system tries to reset three times	Automatic

Table 3 Protection and alarm functions

Protective function	External alarm with alarm relay	Restart	Alarm reset
Motor protection/ overload	Yes, immediately	Manual, disconnect and reconnect power supply	Manual, disconnect and reconnect power supply
Short circuit			
1) RotoSens - manual, disconnect and reconnect the power supply. Rotation monitor with sensor - automatic.			

2. Mounting/connection

2.1 Mounting

Both the motor and the control unit are usually mounted in the heat exchanger housing. In this way, they do not occupy any space outside of the heat exchanger housing and are well protected during transport. Furthermore, it is often advantageous from the point of view of interference (EMC) to place the motor and control unit in the rotor housing. The motor is usually mounted on a sprung motor support when a V-belt is used. In this way, problems arising if non-circular rotors are used can be prevented. Vibration dampers should be mounted between the motor and the motor support so that any vibration from the motor is not transmitted to the rotor housing.

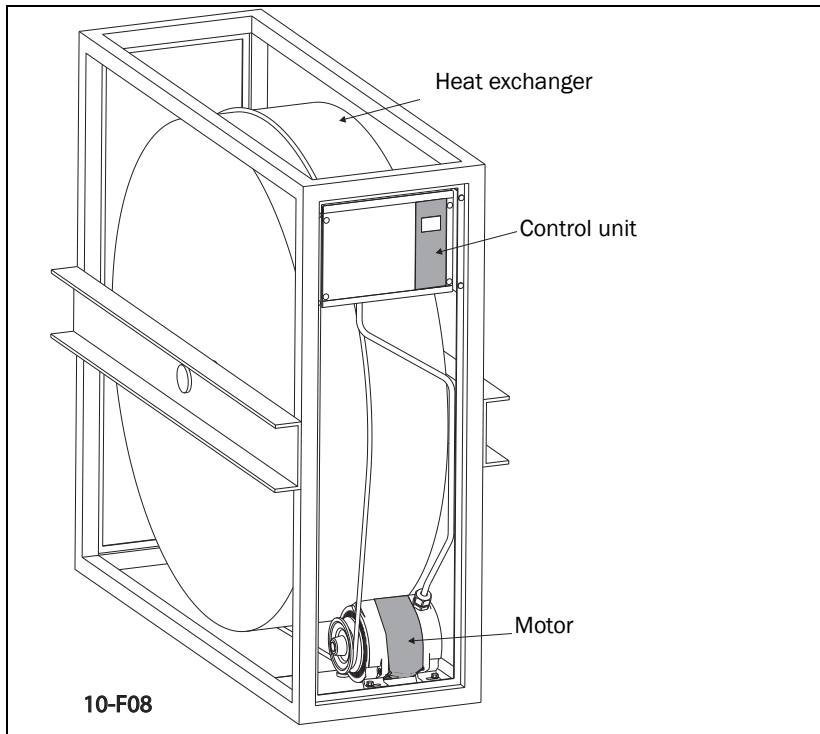

Fig. 2 Heat exchanger rotor and drive system

2.1.1 External sensor for rotation monitor (option)

The magnet for the rotation sensor is mounted onto the periphery of the heat exchanger. If the heat exchanger rotor cover is magnetic, the magnet must be insulated from the cover. The rotation sensor is mounted such that the magnet passes at a distance of 5–8 mm, see below.

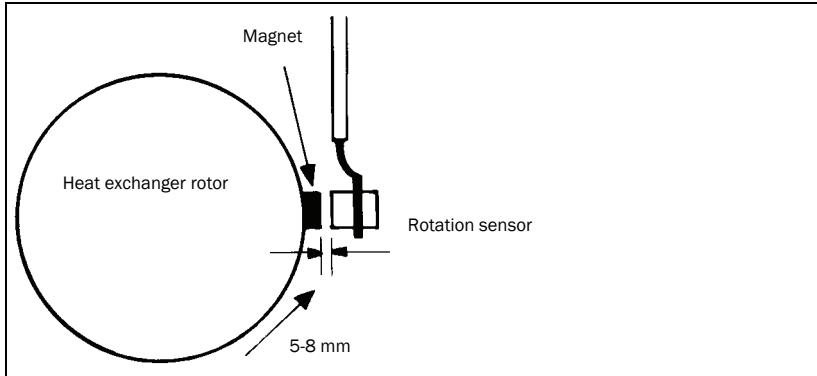

Fig. 3 Mounting of the rotation sensor

2.2 Connection



WARNING! Residual voltage remains for up to 1 minute after disconnection of the supply voltage.

The motor is delivered with a fixed connected motor cable to simplify installation of the drive system. The length of the cable is 2.0 m for EMX-R 15M and 2.5 m for EMX-R 25M and EMX-R 35M.

In order to secure the function of the EMX drive system, do not change the length of the motor cable. This could interfere with the electronic tachometer that is built into the system.

An external slow-blow fuse rated at ≤ 10 A must always be installed. The drive system does not contain a fuse. Electronic motor protection is built into the control unit, and monitors the motor at all times. The control unit is protected from short circuit within the motor.

A safety switch is to be installed between the mains supply and the control unit. An alarm for loss of power is given if the mains supply is disconnected.



WARNING! No switch is allowed between the motor and the control unit.

2.2.1 When switching off

When it is desired to switch off the heat exchanger, for example at night, this can be done using a relay connected in series with the control signal. This relay interrupts the signal to control signal terminal number 33. In this way, no alarm about interruption of power supply is given. The control signal can of course also be reduced to its minimum value, in order to achieve the same result. If the control signal is low or absent the drive system switches to purging mode.

2.2.2 Recommendations with respect to EMC

In order to fulfil the European EMC Directive 89/336/ECC regarding electromagnetic compatibility, the following precautions must be taken:

- The motor cable must be mounted as close to the heat exchanger housing as possible. If the cable is too long, the excess should be collected together in the form of, for example, a figure “8”. The area enclosed by the cable should be as small as possible. Electrical tape or cable ties can be used to achieve this.



Fig. 4 Excess motor cable should be arranged such that the area enclosed is as small as possible

Special EMC couplings/glands are not necessary. An EMC filter is built into all EMX-R models.

2.2.3 Priority switch / defrosting / manual control

A preselected speed of rotation can be specified by a potential-free connection between the priority inputs 34–35. When terminal 34 is connected to terminal 35, the speed is determined by the priority potentiometer, which is located next to the DIP switches in the control unit. The priority switch has higher priority than the summer/winter switch (only available on Model E) and the control signal.

The switch can be used, for example, when cleaning the rotor, defrosting using an external differential pressostat or for manual control of the speed of rotation.

2.2.4 Manual control using a 10 kOhm potentiometer

It is simple to control the drive system manually by using a 10 kOhm potentiometer connected as shown in the figure.

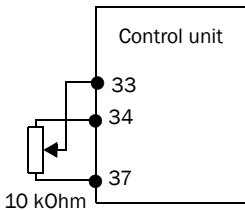

2.2.5 Test switch

The control unit is equipped with a test switch, placed under the cover between terminals 37 and 41. When this switch is in the “ON” position, the motor soft-starts and the speed increases to the maximum, independently of other signal sources. When in the “OFF” position (down), the test switch is not operational.

The test switch can also be used to run the motor at maximum speed if, for example, an external control signal is missing.

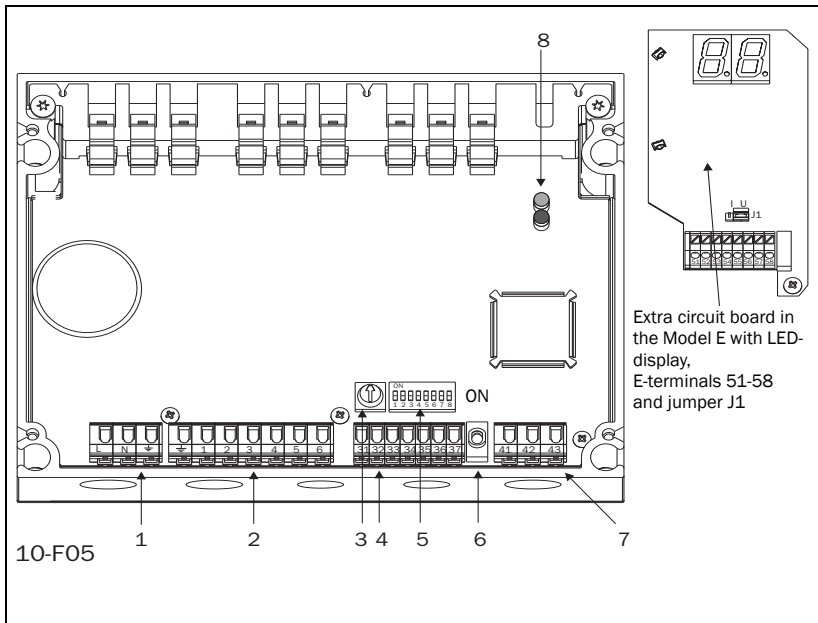

Fig. 5 Location of terminals, etc.

No.	Designation
1	Supply terminal
2	Motor terminal
3	Priority potentiometer
4	Control signal terminal
5	DIP switch
6	Test switch
7	Alarm terminal
8	Operating indicator for Model S, two LEDs

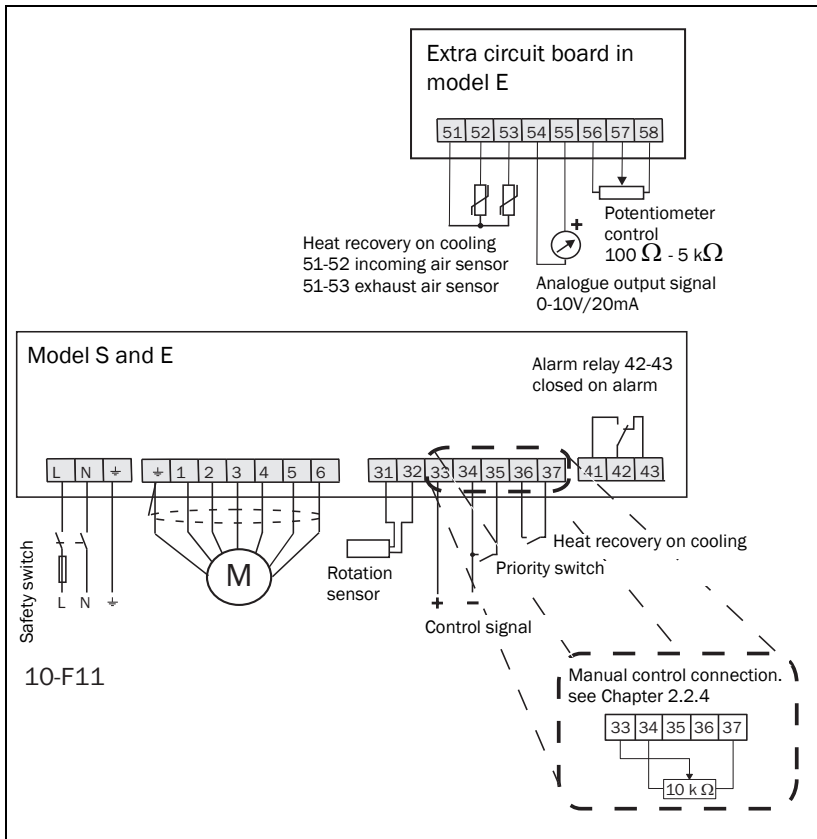
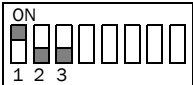
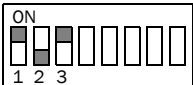
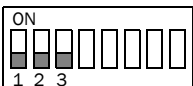

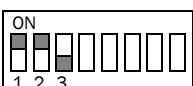
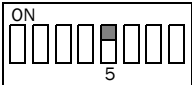
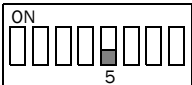
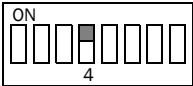
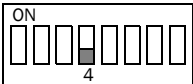



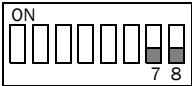
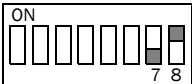
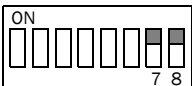

Fig. 6 Wiring diagram

2.2.6 Choice of maximum speed

The maximum speed can be limited to 80% (200 rpm) or 60% (150 rpm). This function is primarily intended for use with rotors smaller than 1.3 m, when it is desired to limit the speed of rotation and/or when using larger belt pulleys.

2.2.7 Setting DIP switches

<p style="text-align: center;">Control signal</p> <p>0-10 V </p> <p>2-10V </p> <p>0-20V </p> <p>4-20mA </p> <p>0-20mA </p>	<p style="text-align: center;">Speed controller</p> <p>V-belt </p> <p>Other belts </p>
<p style="text-align: center;">Rotation monitor</p> <p>With external rotation sensor </p> <p>RotoSens </p>	<p style="text-align: center;">Direction of rotation</p> <p>Clockwise  </p> <p>Counterclockwise  </p> <p style="text-align: center;">Maximum speed</p> <p>100% </p> <p>80% </p> <p>60% </p>



WARNING! Disconnect the voltage supply before changing the DIP switch settings.

2.2.8 Speed controller

DIP switch 5 on the control unit can be used to select between two speed controllers. One controller provides gentler operation and is used if resilient belts such as round belts, flat belts and resilient V-belts are fitted. In this case DIP switch 5 should be set “OFF”. The other controller is faster and stiffer, and is intended for use with stiff belts such as V-belts and homogenous round belts. In this case DIP switch 5 should be set “ON”.

If the stiffer controller is not adequate for smooth operation when the max. speed is set to 100%, an even stiffer and faster controller can be selected by setting DIP switches 5 and 7 “ON” and setting DIP switch 8 “OFF”.

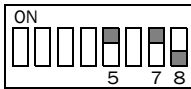

2.2.9 Parallel connection

If several rotary heat exchangers are to be used in parallel using one control signal or sensor, each heat exchanger rotor must be equipped with its own drive system (motor and control unit).

The control signal is connected to the first drive system according to the instructions for connection. The other control units are connected by connecting terminals 33 and 34 of the other control units to terminals 33 and 34, respectively, on the first control unit.

The DIP switches on the first control unit are set as described in “Setting DIP switches”. DIP switch 1 and DIP switch 3 on the other control units are set as described in “Setting DIP switches”, while DIP switch 2 is always set as described below:

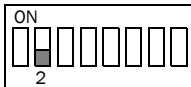

The control units give individual alarms. The alarm outputs can be connected in parallel or in series in order to obtain a collective alarm.

Model E can also use the analogue output signal in order to control other drive systems. Terminals 54(-) and 55(+) are connected to terminals 34(-) and 33(+),

respectively. The DIP switches on all control units are set as described in “Setting DIP switches”.

2.2.10 Heat recovery on cooling – summer/winter switch

Heat recovery on cooling refers to the mode of operation when the incoming air temperature exceeds the exhaust air temperature. By driving the rotary heat exchanger at maximum speed, a cooling effect is achieved on the incoming air. The heat recovery on cooling function is most simply obtained by using an external regulator which has this function built-in. EMX-R is then controlled by a control signal, e.g. 0–10 V.

If for example, an external regulator is already installed, you can obtain the heat recovery on cooling function by directly connecting a separate differential thermostat to EMX-R, terminals 36–37

Model E has a built-in differential thermostat. This makes it possible to connect two NTC sensors of resistance 2000 Ohm (for example EGL 511), one in the incoming air duct and one in the exhaust air duct, directly to EMX-R, terminals 51–53. If the exhaust air is colder than the incoming air, the rotor rotates at its maximum speed, and cooling is recovered. If the exhaust air is warmer than the incoming air (as is normally the case) the speed is controlled by the control signal, and heat is recovered.

2.2.11 Analogue output signal (only available on Model E)

The output signal, 0–20 mA or 0–10 V, is proportional to the speed of the motor. Maximum value, 20 mA or 10 V, is always obtained at the selected max. speed (60, 80 or 100% of the motor’s maximum rpm). The choice between the 0–20 mA output signal and the 0–10 V output signal is made with jumper J1 positioned behind the control terminals 51–58.

2.2.12 Potentiometer with low resistance, 100 Ohm to 5 kOhm (only available on Model E)

When control is provided by an external potentiometer with a total resistance value between 100 Ohm and 5 kOhm, the three leads are connected to terminals 56–58. DIP switches 1–3 are set in the same way as for a control signal of 0–10 V.

3. Maintenance/troubleshooting



WARNING! Residual voltage remains for up to 1 minute after disconnection of the supply voltage. The test switch and the DIP switches may only be adjusted when the supply voltage has been disconnected.

3.1 Maintenance

The motor and the controller do not normally require any maintenance. However, it should be regularly checked that the cabling is not damaged and that all fixing screws are securely tightened.

3.2 Motor diagnosis

Disconnect the supply voltage. Disconnect the motor cables from the control unit. Measure the motor resistance between 1–2, 3–4 and 5–6. The values should be:

15M: 30–90 Ohm; 25M: 5–15 Ohm; 35M: 5–15 Ohm

The resistance should not differ by more than 5 Ohm between the phases for 15M, and by no more than 2 Ohm for 25M/35M. Also check the insulation resistance between 1–3, 1–5, 3–5, 1–earth, 3–earth and 5–earth.

Note! When checking the insulation resistance, it is important to turn the motor shaft slowly (at least one complete turn) in order to get a correct measurement.

3.3 Troubleshooting

Check that the equipment has been correctly installed, i.e. that the cables are properly stripped, that there are no loose cables, etc., and check that the DIP switches are correctly set. Check that Control unit and motor have the correct size, Control unit EMX-R-15S(or E) could only work with motor EMX-R-15M and so on.

It is always possible to test run the drive system using the TEST switch located under the cover next to terminal 37, see Fig. 5, page 15. The switch has two fixed positions, when it is in the up position, the motor accelerates to its maximum speed independent of the control signal, and when it is in the down position the rotation speed is controlled by the control signal.

If the motor does not reach maximum speed or respond to the control signal, check DIP switches 1–3 and 7 and 8. If the heat exchanger rotates in the wrong direction, change the setting of DIP switch 6. Reset, vibration, noise and built-in protection are described in the chapters Description and Mounting/Connection.

If the control unit is to be exchanged, the complete covered box containing the circuit boards must be exchanged.

Table 4 Troubleshooting

Alarm indication			Fault condition/Action required
S	E	Fault	
Green LED flashes slowly	Q1	Purging/ low control signal	Check the drive system with the test switch located next to terminal 37. The motor should accelerate to its maximum speed. If the motor does not accelerate to the maximum speed when the test switch is activated, the fault is external. Is the control signal between 33(+) and 34 (-) present? Have + and - been swapped?
Red and green LED flash rapidly	P3	Pre-alarm rotation monitor	The drive system has switched to a softer speed controller because the motor shaft is jerking sharply. Check that the drive belt is not slipping on the pulley.
Red LED flashes rapidly	F3	Rotation monitor	The exchanger rotor does not rotate; check the drive belt. The rotor rotates; check that the indication is given when the magnet passes the rotation sensor, see the section Operating indicators, if not replace the rotation sensor. If RotoSens is used, check that the rotor or belt pulley are not smaller than 630 mm respective 63 mm. Check function of the rotation sensor: Measure with a Multimeter between terminal 31 and 32, correct sensor measures < 1 V when the magnet passes the sensor.
Red LED is lit and green LED flashes rapidly	P5	Pre-alarm, overload/ motor protection	The motor protection has been activated due to excessive load. After a cool-down period of 10 minutes the system restarts automatically. If the overload protection trips 3 times within 120 minutes the drive system will be shut down, see also overload (F5).

Table 4 Troubleshooting

Alarm indication			Fault condition/Action required
S	E	Fault	
Red LED is lit	F5	Overload/ motor protection	The motor protection has been activated due to excessive load. Check that the motor cables are connected correctly, see the chapter on Mounting/Connection. Check also that the rotor runs freely and that the diameters of the rotor and pulley is according to Table 9 page 29. If wrong pulley is mounted, change pulley or change max. speed with DIP-switch 7 and 8 acc. to chapter 2.2.7 page 17. If the fault remains, carry out motor diagnosis. Replace the motor if it is faulty. If the fault does not lie within the motor, replace the control unit.
No LED lit	-	Supply voltage missing	Check that 230 VAC \pm 15% is connected to the supply terminal.
Red and green flash slowly and alternately	F1	Overvoltage	The supply voltage exceeds 264 VAC.
	F2	Under- voltage	The supply voltage lies below 196 VAC.
Red and green LED flash rapidly and alternately	F6	Earth fault in the motor	Disconnect the supply voltage, check the connection of the motor cable and check that the correct motor is connected. If the fault remains, carry out motor diagnosis. If the motor is faulty, replace it. If the fault does not lie within the motor, replace the control unit.
Red LED flashes slowly	F7	Short circuit in the motor	
	F8	Circuit break in the motor	
	F9		

Table 4 Troubleshooting

Alarm indication			Fault condition/Action required
S	E	Fault	
Motor runs irregularly			Check belt tension. If DIP-switch 5 = OFF and there is a stiff belt mounted, change speed controller by setting DIP-switch to ON.

4. Technical data

Table 5 Technical data

Function		EMX-R		
		15	25	35
Output data	Rotation speed [rpm]	5-250		
	Torque ¹⁾ [Nm]	1.5	4	6
	Power [W]	40	100	160
	Direction of rotation	Selectable		
	Purging mode	Built-in function		
	Motor protection	Built-in function		
	Soft start and stop [s]	15/15	25/25	35/35
	Alarm output	Alternating contact, max 5 A 230 VAC		
Input data	Supply voltage	230 VAC \pm 15%, 50/60 Hz		
	Current [A]	0.7	1.3	1.7
	Control signal	0-10 V, 2-10 V, 0-20V phase cut, 0-20 mA, 4-20 mA, 10 kOhm potentiometer		
General	Protection class	IP 54		
	Weight, control unit [kg]	1.4	1.7	
	Weight, motor [kg]	5	8	11
	Terminals	1 pc M12 and 4 pc M20 (glands)		
	Ambient temperature	-30 - +40° C		
	Tachometer	Electronic tachometer, tachometer cable is not needed		
	EMC, Emission	EN 61000-6-3/EN 61000-6-4		
	EMC, Immunity	EN 61000-6-2		

¹⁾ Torque is constant over entire speed range.

4.1 The drive system's operation using different control signals

The drive system has a built-in linearity function that gives a linear relationship between the control signal and the efficiency of the heat exchanger rotor, rather than having the speed of rotation proportional to the control signal. This provides good conditions for stable temperature control.

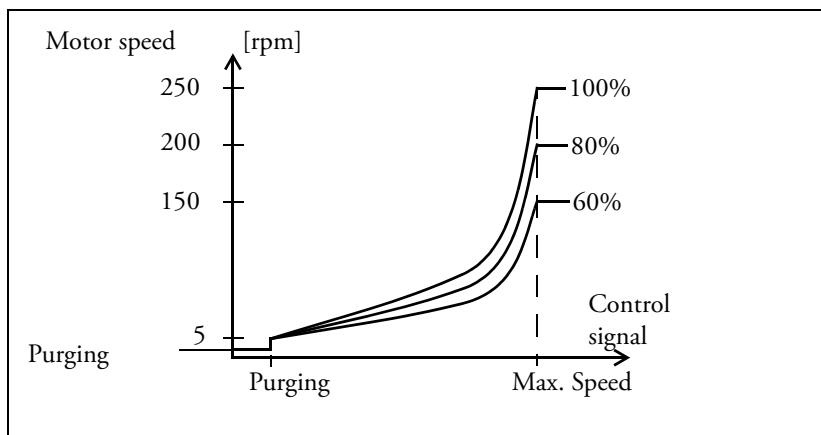

Control signal	Purging	Maximum speed
0-10 V	1,5 V	9,7 V
2-10 V	3 V	9,7 V
0-20 V	3 V	19,4 V
4-20 mA	6 mA	19,4 mA
0-20 mA	3 mA	19,4 mA

Table 6 Motor model designations

Article number	Designation	Notes
01-2160-00	EMX-R-15M	Cable 2.0 m
01-2162-00	EMX-R-25M	Cable 2.5 m
01-2163-00	EMX-R-35M	Cable 2.5 m

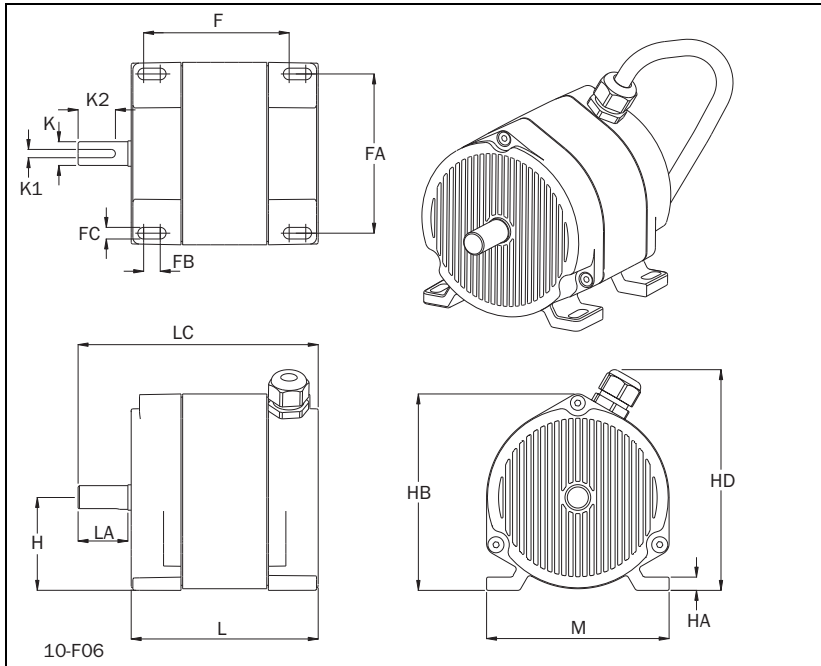

Fig. 7 Motor dimensions

Table 7 Motor dimensions (mm)

EMX-R	F	FA	FB	FC	H	HA	HB	HD
15	88	96	10	7	56	8	119	134
25	82	140	12	7	81	10	173	180
35	109	140	12	7	81	10	173	180
EMX-R	K	K1	K2	L	LA	LC	M	
15	14j6	5h9	20	113	30	145	110	
25	14j6	5h9	20	114	35	152	160	
35	14j6	5h9	20	141	35	179	160	

Table 8 Control unit model designations

Article number	Designation
01-2170-11	EMX-R-15S
01-2171-11	EMX-R-15E
01-2174-11	EMX-R-25S
01-2175-11	EMX-R-25E
01-2176-11	EMX-R-35S
01-2177-11	EMX-R-35E

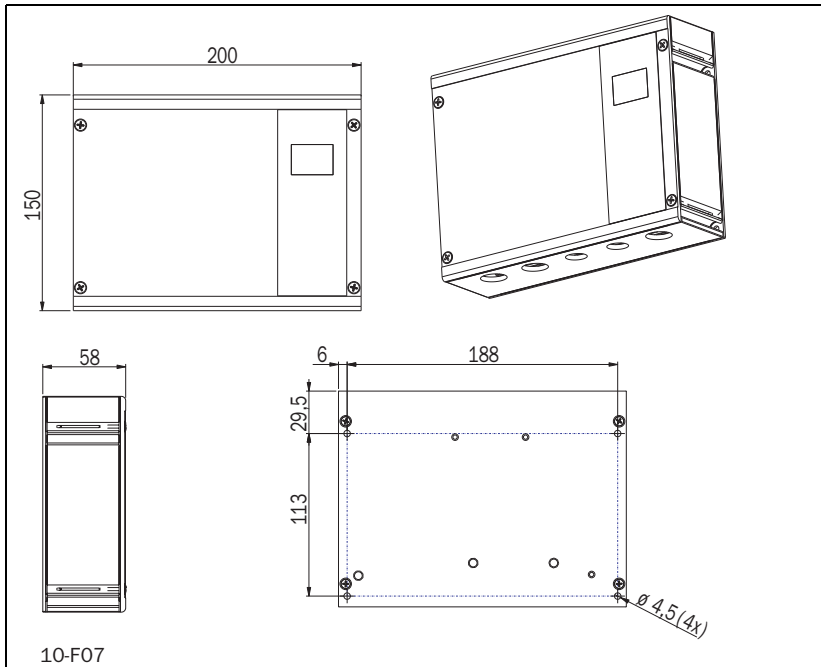

Fig. 8 Control unit dimensions (mm)

4.2 Choice for sizes of drive system and belt pulley

Table 9 Choice of size for drive system and belt pulley

Rotor diameter [mm]	EMX-R model	Belt pulley diameter [mm]	Maximum speed of revolution [%]	Rotor speed [rpm]
700	15	63	60	13.5
700	15	30	100	10.7
900	15	63	60	10.5
900	15	40	100	11.1
1100	15	63	80	11.5
1100	15	50	100	11.4
1300	15	71	80	10.9
1300	15	63	100	12.1
1500	15	71	100	11.8
1700	25	80	100	11.8
1900	25	80	100	10.5
2100	25	100	100	11.9
2300	25	100	100	10.9
2500	25	100	100	10.0
2700	35	118	100	10.9
3100	35	140	100	11.3
3500	35	140	100	10.0

NOTE: Higher rotor speeds than those given in the table above increase the loading and a larger drive system may be necessary. Tight rotor seals may also require the use of a larger size. Rotors that have a high capacity to absorb humidity, such as dehumidification rotors in desiccant cooling system requires a larger drive system, see separate documentation.

4.3 Accessories and documentation

Table 10 Accessories

Article number	Designation
01-2184-00	Rotation sensor with magnet M12 x 75 mm
01-3549-00	Rotation sensor with magnet M12 x 35 mm
01-3660-00	Cable fixture for control unit 15-35
01-2182-00	Mounting kit, expander type for motor 15-35
01-2183-00	Mounting kit 2*M6 for motor 15-35

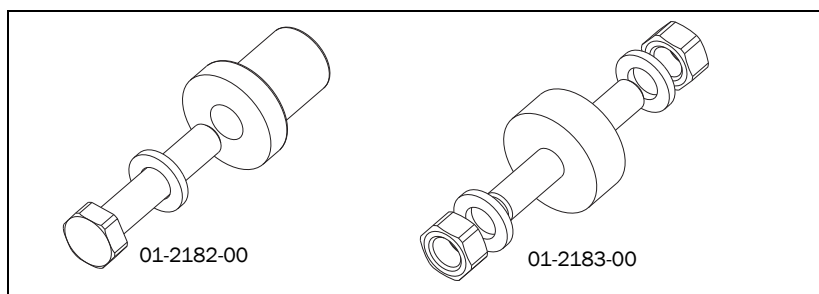

Fig. 9 Mounting kits with vibration damping for motor

Table 11 Operating instructions

Article number	Designation
01-3333-00	Swedish instruction manual
01-3333-01	English instruction manual
01-3333-02	German instruction manual
01-3333-03	Dutch instruction manual
01-3333-05	Danish instruction manual
01-3333-06	Norwegian instruction manual
01-3333-07	Finnish instruction manual
01-3333-08	French instruction manual
01-3333-13	Polish instruction manual

5. Appendix

Connection table

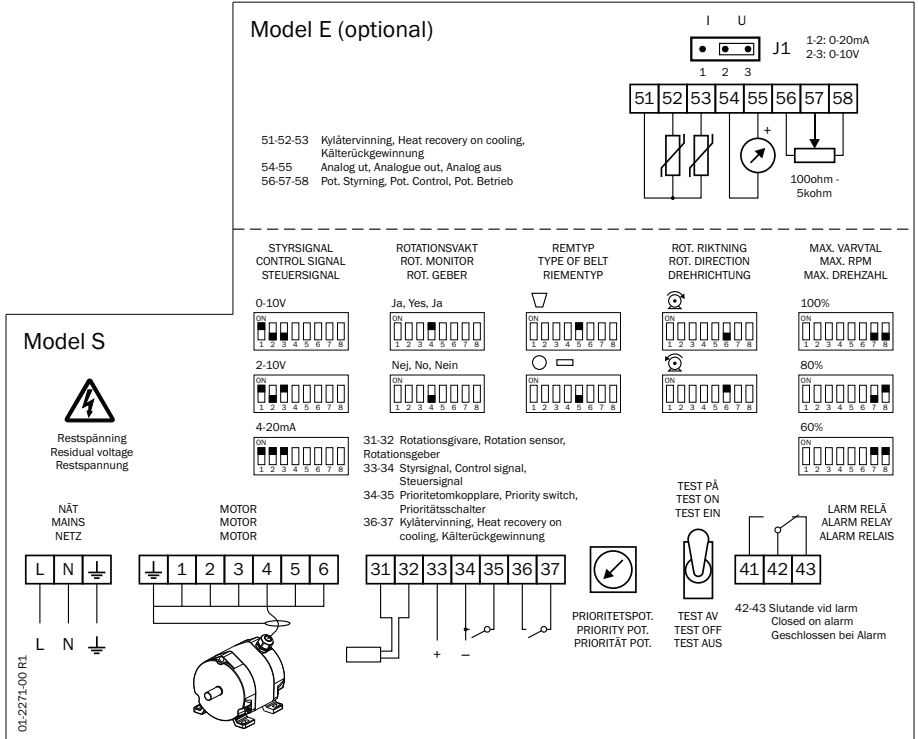

Model S

EMX-R



● GRÖN GREEN GRÜN

Långsamt blinkande	- Renblåsningsdrift
Snabbt blinkande	- Drift
Lyser i 2 s	- Magneten passerar rotationsgivaren

Slowly flashing	- Cleaning operation
Fast flashing	- Operation
Lit for 2 sec.	- The magnet passes the rotation sensor

Langsam blinkend	- Intervallbetrieb
Schnell blinkend	- Betrieb
Leuchtet 2 Sek. lang	- Rotormagnet passiert Rotationsgeber

● RÖD RED ROT

Blinkande	- Rotationsalarm
Lyser	- Överlast

Flashing	- Rotation alarm
Lit	- Overload

Blinkend	- Rotationsalarm
Leuchtet	- Überlast



⚡ VARNING! WARNING! ACHTUNG!
 Bryt spänningen innan locket öppnas
 Turn off supply before removing cover
 Gerät vor dem Öffnen vom Netz trennen

emotron

Model E

EMX-R



	Integrerad elektr. rotationsvakt Integrated electr. rotation monitor Integrierter elektr. Rotationswächter
	Rotorvarvtal; Ext. rotationsgivare Rotor speed; Ext. rotation sensor Rotordrehzahl; Ext. Rotationsgeber
	Renblåsningsdrift Cleaning operation Intervallbetrieb
	Signal från extern rotationsgivare Signal from external rotation sensor Signal von externem Rotationsgeber
	Rotationsalarm Rotation alarm Rotationsalarm
	Överlast Overload Überlast

⚡ VARNING! WARNING! ACHTUNG!
 Bryt spänningen innan locket öppnas
 Turn off supply before removing cover
 Gerät vor dem Öffnen vom Netz trennen

emotron



DEDICATED DRIVE

Emotron AB, Mörsaregatan 12, SE-250 24 Helsingborg, Sweden

Tel: +46 42 16 99 00, Fax: +46 42 16 99 49

E-mail: info@emotron.se

Internet: www.emotron.com